

# FORZA<sup>®</sup> HYDRAULICS

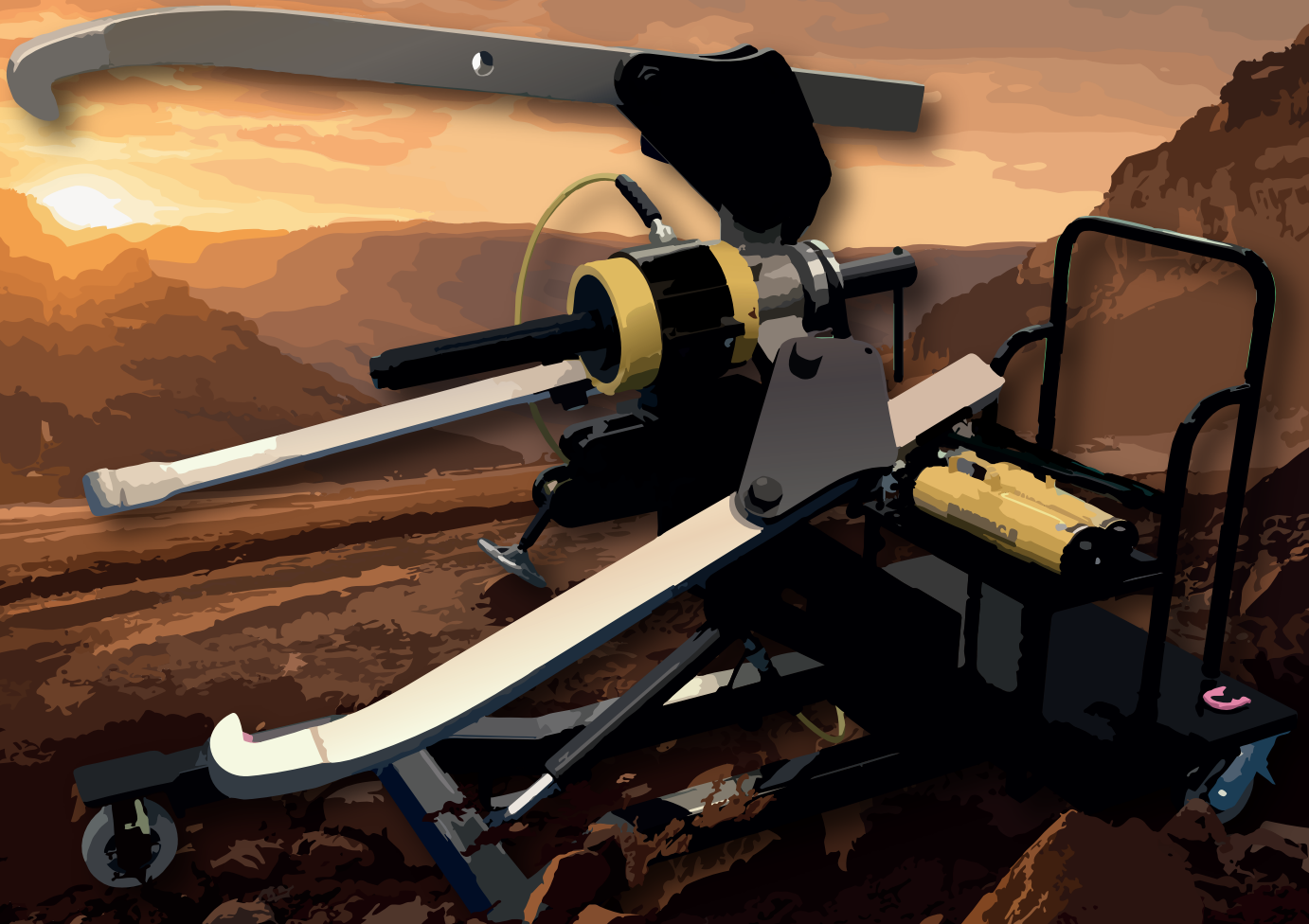

High-Force Performance ·  
Precision Engineering · Safety Assured



**NO PULLING LIMITS,  
JUST FORZA TOOLS**

# • HYDRAULIC PULLERS •



**Railway**



**Petrochemical**



**Public works**



**Mining**



**Wind Energy**



**Marine**



In maintenance situations, there are parts such as bearings, pulleys, gears, shafts or bearings that are needed to be removed. Difficult access, tightening conditions and other factors make that these parts cannot be safely removed without the use of a professional puller.

These types of parts are most often found mounted on a machine, installation or vehicle. Forza offers fast, efficient, safe and gentle disassembly.

Forza pullers means high productivity, costs savings and long-term machine life. It is cheaper to buy a Forza puller than to pay for downtime costs and investment in new machinery.

#### **When to choose a hydraulic puller?**

Manually or mechanically a maximum nominal force of 4-5Tons can be reached, which it is not enough in many cases. The working position as well as the “physical limitations” must be taken into account. For this reason, we always recommend a hydraulic drive from 8 Tons upwards.

Hydraulic pullers are usually known by their capacity in tons, this capacity is generally proportional to the dimensions of the workpiece to be extracted

# • 2 JAWS AND PUSH HYDRAULIC PULLERS •

## SERIE 00900 HYDRAULIC PARTS

00900

**PRESSURE GAUGE  
NOT INCLUDED**



The hydraulic part of the extractor consists of a cylinder and a pump. The cylinder is the part that exerts the force on the puller.

They are single-acting cylinders with a spring return.

The pump is the part that introduces the pressurized oil into the cylinder, the pumps can work up to 700 bar.

It is very important to pay special attention to the pressure gauge and for safety never exceed the red pressure zone, included in the pump.

It is very important to pay special attention to the pressure gauge and for safety never exceed the red pressure zone, included in the pump.

The hose is included in the pump (length: 1.8m).

Equipment 00904 and 00909 do not include pressure gauge.



Ref.	Price/€	TON		Cylinder	Pump
00904	1.089,00	4	5.2	09041	009542
00909	1.460,00	10	14	09091	009542

Ref.	Price/€	TON		Cylinder	Pump
00910	1.692,00	12	11.2	09101	09102
00918	2.213,00	20	16	09181	09102
00930	2.244,00	30	19	09301	09102
00952	4.174,00	60	43	09521	09522
00995	7.506,00	100	78	09951	09522

## SERIE 1000H 2 JAWS PULLERS' MECHANICAL PART

1000H



Mechanical part of serie 3000H.  
2 external fixed jaws puller .

### Bullet points

- Hydraulic mechanism: faster pulling with less effort.
- Point protector included for a better use.



Ref.	Price/€						Spare parts		Accessories
		A	B <sub>Max</sub>	B <sub>Min</sub>	C		Complete jaw	Spindle	Point protector
1018H	679,30	260	280	105	370	20	102050	101883	111837
1018LH	780,30	390	280	115	370	25.8	102060	101883	111837

## SERIE 3000H COMPLETE HYDRAULIC PULLER

3000H



Ref.	Price/€		Hydraulic part	Mechanical part
3018H	3.022,30	36	00918	1018H
3018LH	3.123,30	41.8	00918	1018LH



# • 2 JAWS AND PUSH HYDRAULIC PULLERS •

## SERIE 1000HF 2 JAWS PULLERS' MECHANICAL PART

1000HF

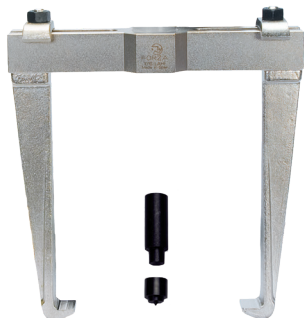

Mechanical part of serie 3000H.

2 external fixed jaws puller .

Point extension included:





-130789 extens 55mm.

-131089 extens 85mm.



### Bullet points

- Hydraulic system: faster pulling with less effort.

Ref.	Price/€					TON		Spare parts	
								Extension included	Complete jaw
1010AHF	269,60	160	200	60	260	5	3.5	130789	101050
1010HF	270,40	160	150	60	210	5	3.1	130789	101050
1010LAHF	282,80	220	200	60	260	5	4	130789	101060
1010LHF	283,60	220	150	60	210	5	3.6	130789	101060
1020HF	476,00	260	250	60	345	10	12	131089	102050
1020LHF	609,40	300	245	60	345	10	14	131089	102060

## SERIE 3000HF COMPLETE HYDRAULIC PULLER

3000HF



2 external fixed hydraulic jaw puller.

Point extension included.

### Bullet points

- Hydraulic system: faster pulling with less effort.



Ref.	Price/€	TON		Hydraulic part	Mechanical part
3010AHF	1.470,10	5	21	00904	1010AHF
3010HF	1.470,90	5	20	00904	1010HF
3010LAHF	1.483,30	5	21	00904	1010AHF
3010LHF	1.484,20	5	20	00904	1010LHF
3020HF	2.036,00	10	32	00909	1020HF
3020LHF	2.165,40	10	35	00909	1020LHF

# • 2 JAWS AND PUSH HYDRAULIC PULLERS •

## SERIE 1100H MECHANICAL PART

1100H

INCLUDED IN CPE  
AND XPE SET







Mechanical part of the serie 3100H.

These pullers combine with the 1200 splitters and are the safest way to remove pulleys without damaging them.



### Bullet points

- These pullers can be used with plate jaws.
- It can be also used as push pullers with serie 1500 and 4700 internal pullers.
- Point protector included for a better use.

Ref.	Price/€					TON		Accessories		Spare parts		Accessories		
								Internal puller	Splitter	Spindle	Complete extension	Other extensions	Plate jaw	Point protector
1110H	410,50	300	260	115	280	12	7.3	1506H10 1507H10 4704H10	1204B 1206B	111083	111080H	1110-209H 1110-540H	112005 112006	111037
1118H	681,90	265	345	140	370	20	14	1506H20 1507H20 4704H20	1206B 1208B	111883	111880H		112005 112006	111837
1130H	1.277,20	284	440	180	480	30	36	1509H30 4708H30	1208C 1210C	113083	113080H	1130-328 1130-836	113505	113037
1152H	2.234,30	447	580	220	615	60	70.5	1509H50 4708H50	1210D 1212D 1213D	115283	115280H	1152-504 1152-1076	115005	113037
1195H	3.985,30	600	700	340	760	100	168.3	4708H95	1213E	119583	119580H	1195-660		119537

## SERIE 3100H COMPLETE HYDRAULIC PULLER

3100H



Ref.	Price/€	TON		Hydraulic part	Mechanical part
3110H	2.232,50	12	32	00910	1110H
3118H	2.996,90	20	51	00918	1118H
3130H	3.710,00	30	71	00930	1130H
3152H	6.690,80	60	143	00952	1152H
3195H	11.491,00	100	21	00995	1195H

# • SPLITTERS •

## SPLITTER SERIE 1200

1200

INCLUDED IN CPE  
AND XPE SET

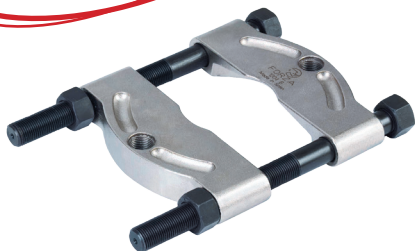

### Separator





It combines with 1100, 1100S mechanical pullers series and with the 1100H hydraulic puller series.

Splitters are used to remove bearings or other parts when there is not enough space to use a jaw puller.



### Bullet points

- The part to pull out must rest against the flat side of the splitter.

Ref.	Price/€				Conection		Push puller
1204B	140,60	110	10	110	5/8"	2.8	1110H; 1108AH
1206B	286,80	134	12	155	5/8"	5.7	1110H; 1118H; 1108H
1208B	437,20	210	13	180	5/8"	12.5	1118H
1208C	437,20	210	13	180	1"	12.5	1130H
1210C	927,80	255	17	260	1"	28.5	1130H
1210D	927,80	255	17	260	1-1/4"	28.5	1152H; 1150
1212D	1.407,00	300	20	300	1-1/4"	43.5	1152H
1213D	2.502,00	300	35	330	1-1/4"	86.5	1152H
1213E	2.586,60	315	40	343	1-1/4"	83.5	1195H

## PUSH PULLER -SPLITTER

The size of the pulley to be pulled out is taken by the measurement C, not B.

### Correct assembly of splitters

- The part to pull out must rest against the flat side of the splitter.
- The puller arms must be positioned as close as possible to the piece to be pulled out
- This is distance C; it must be almost equal to  $\varnothing B$ .

Ref.	A	B	C
1110H+1204B	275	110	155
1110H+1206B	275	125	222
1118H+1206B	262	134	230
1118H+1208B	425	213	300
1130H+1208C	241	213	290
1130H+1210C	241	250	372
1152H+1210D	380	250	362
1152H+1212D	380	300	435
1152H+1213D	380	300	450
1195H+1213E	565	315	535

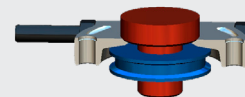
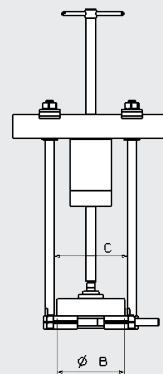
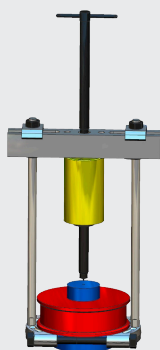

# • OSCILLATING JAWS PULLERS •

## SERIE 1300LTH 2/3JAWS PULLERS' MECHANICAL

1300LTH







Mechanical part of serie 3300LTH.  
External 2/3 jaws hydraulic puller.  
Long jaws (3 holes).  
Point extension included.  
130789 extend 55mm.  
130789 extend 55mm.  
131089 extend 85mm.



### Bullet points

- Hydraulic system: faster pulling with less effort.
- 3 jaw positions.
- Possibility of use with 2 or 3 jaws.

Ref.	Price/€					TON		Spare parts	
								Extension included	Complete jaw
1307LTH	198,60	225	240	130	40	5	3.5	130789	130760
1310LTH	401,90	400	350	176	60	10	9.5	131089	131060
1310XTH	425,60	480	405	176	60	10	11.9	131089	131066

## SERIE 3300LTH COMPLETE HYDRAULIC PULLER

3300LTH

External 2/3 jaws hydraulic puller.  
Long jaws (3 holes).  
Point extension included.



### Bullet points

- Hydraulic mechanism: faster pulling with less effort.
- 3 jaw positions.
- Possibility of 2 or 3 legs pulling.
- The pull out improves thanks to the three jaws.

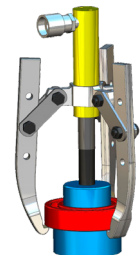

Ref.	Price/€	TON		Hydraulic part	Mechanical part
3307LTH	1.399,10	5	20	00904	1307LTH
3310LTH	1.959,20	10	33	00909	1310LTH
3310XTH	2.005,60	10	36	00909	1310XTH

# • SELF CENTERING PULLERS •

## SERIE 1300THA MECHANICAL PART

## 1300THA

**INCLUDED IN CPE  
AND XPE SET**





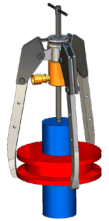

Mechanical part of serie 3300THA.  
External 3 selfcentering jaws puller.  
Long jaws (3 holes).



### Bullet points

- Automatic selfcentering of the jaws, for a better grip.
- 2 or 3 legs pulling.
- Point protector included for a better use.
- The pull out improves thanks to the three jaws.

Ref.	Price/€					TON	Position		Spare parts			
									Jaw	Spindle	Point protector	Ring kit with straps and bushing
1310THA	605,50	315	350	60	177	12	2/3 patas	14.5	131006	111083	111037	1310K3
1318THA	990,60	320	480	80	276	20	3 patas	33	131706	111883	111837	1318K3
1330THA	1.514,50	410	650	100	325	30	3 patas	56.5	133006	113083	113037	1330K3
1352THA	2.877,80	710	980	150	414	60	3 patas	122	135206	115283	113037	1352K3
1395THA	7.538,40	1000	1600	300	597	100	3 patas	322	139506	119583	119537	

## SERIE 3300THA COMPLETE HYDRAULIC PULLER

## 3300THA



Ref.	Price/€	TON		Hydraulic part	Mechanical part
3310THA	2.352,00	12	35	00910	1310THA
3318THA	3.284,00	20	66	00918	1318THA
3330THA	3.920,00	30	81	00930	1330THA
3352THA	7.310,00	60	177	00952	1352THA
3395THA	15.044,00	100	465	00995	1395THA

### Why self centering?

- All the jaws move at the same time
- Offers easier positioning of the puller even in difficult to get at place
- The self centering puller is safe thanks to its kaw device in max spread position.
  - Working wit the extractor more open implies:
    - Incorrect support of the legs.
    - Risk of loosening

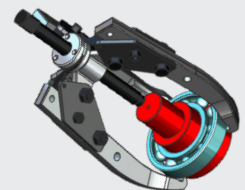

# • SELF CENTERING PULLERS •

## SERIE 1300THXA MECHANICAL PART

1300THXA

INCLUDED IN CPE  
AND XPE SET







Mechanical part of serie 3300THXA.  
External 3 jaws puller.  
Extra long jaws (4 holes).



### Bullet points

- Automatic selfcentering of the jaws, for a better grip.
- 4 jaw positions.
- Point protector included for a better use.
- The pull out improves thanks to the three jaws.

Ref.	Price/€					TON	Position		Spare parts			
									Jaw	Spindle	Point protector	Ring kit with straps and bushing
1310THXA	680,80	395	410	60	176	12	2/3 patas	16	131016	111083	111037	1310K3
1318THXA	1.054,20	435	540	80	276	20	3 patas	36	131716	111883	111837	1318K3
1330THXA	1.553,50	535	720	100	325	30	3 patas	62.5	133016	113083	113037	1330K3
1352THXA	2.952,90	860	1080	150	414	60	3 patas	131	135216	115283	113037	1352K3

## SERIE 3300THXA COMPLETE HYDRAULIC PULLER

3300THXA



Complete puller: mechanical part + hydraulic part.  
External 3 jaws selfcentering puller.  
Extra long jaws (4 holes).



### Bullet points

- Hydraulic system: faster pulling with less effort.
- Better grip thanks to the automatic centering of the jaws.
- 4 jaw positions.
- Point protector included for better use.

Ref.	Price/€	TON		Hydraulic part	Mechanical part
3310THXA	2.405,00	12	36	00910	1310THXA
3318THXA	3.378,00	20	69	00918	1318THXA
3330THXA	3.958,00	30	87	00930	1330THXA
3352THXA	7.127,00	60	187	00952	1352THXA

# INTERNAL PULLERS

## SERIE 4704H 3 EXTERNAL AND INTERNAL JAWS

4704H

INCLUDED IN CPE  
AND XPE SET



External and internal 3 jaw puller.

With 2 sets of 3 jaws.

470405 is the jaw for internal and external use with a diameter bigger than 97mm.







470415 is the leg for indoor use with a maximum diameter of 97mm.

Combines with push pullers of serie 1100H.



### Bullet points

- Perfect for cylinder liners.
- Self-centering system: automatic centering of the jaws for a better grip.

Ref.	Price/€	 $\varnothing$ int	 $\varnothing$ int	 $\varnothing$ ext	 A	 A		Mechanical part	Exterior jaw	Spindle	Internal jaw
4704H10	388,10	45-97	95-150	40-130	65	140	3.1	1110H	470405	470485	470415
4704H20	398,00	45-97	95-150	40-130.	65	140	3.1	1118H	470405	470486	470415

## SERIE 4708H INTERNAL JAWS PULLER

4708H

INCLUDED IN CPE  
AND XPE SET



3 jaws internal puller.

Combines with push pullers of serie 1100H.



### Bullet points

- Perfect for cylinder liners.
- Self-centering system: automatic centering of the jaws for a better grip.



Ref.	Price/€	Maximum internal opening	Useful jaw height	Thread	Body diameter		Push puller	Jaw	Spindle
4708H30	300	315	130	150	1 1/4"7h	10,8	1130H	150905	470885
4708H50	300	315	130	150	1 5/8"5,5h	11,2	1152H	150905	470886
4708H95	300	315	130	150	2 1/2" 8h	12,0	1195H	150905	470896
4709H95	320	315	130	168	2 1/2"8h	14,2	1195H	150905	470989

# • HYDRAULIC MASTER SETS •

## SERIE CPE MECHANICAL PART

CME

*new*



Mechanical part of CPE hydraulic set.



Ref.	Price/€	Push puller	Splitter	Internal puller	Self-centering puller 2 y 3 jaws	TON		Point protector
C0-10E	1.946,00	1110H	1204B	4704H10	1310THA	12	43	111037
C1-18E	2.897,00	1118H	1206B	4704H20	1318THA	20	93	111837
C2-30E	5.289,00	1130H	1210C	4708H30	1330THA	30	144	113037
C3-50E	8.781,00	1152H	1212D	4708H50	1352THA	60	279	113037
C4-95E	15.550,50	1195H	1213E	4709H95	1395THA	100	572	119537

## SERIE CPE COMPLETE HYDRAULIC SET

CPE



CPE complete hydraulic set.

In addition to the puller described in the table, it includes:

- 2 pairs of extra extensions.
- 2 link nuts.

Point protector.

### Bullet points

- Hydraulic system: faster pulling with less effort.
- Versatility: with one set you can have many possibilities of extractions.
- Automatic centering of the jaws, for a better grip.
- Palletized black metal box.



Can be mounted

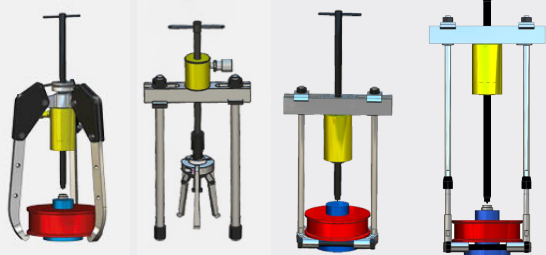

Ref.	Price/€	TON		Hydraulic part	Mechanical part
CP-10E	3.648,00	12	57	00910	C0-10E
CP-20E	5.120,00	20	97	00918	C1-18E
CP-30E	7.522,00	30	166	00930	C2-30E
CP-50E	12.955,00	60	326	00952	C3-50E
CP-95E	23.056,00	100	660	00995	C4-95E

### Hydraulic part



### Mechanical part



# • HYDRAULIC MASTER SETS •

## SERIE XPE MECHANICAL PART

*new*

XME



Mechanical part of XPE hydraulic set.



Ref.	Price/€	Push puller	Splitter	Internal puller	TON	⚖️	Point protector
X0-10E	1.999,00	1152H	1212D	4704H10	1352THX	44	111037
X1-18E	2.632,00	1118H	1206B	4704H20	20	97	111837
X2-30E	5.342,00	1130H	1210C	4708H30	30	149	113037
X3-50E	8.858,00	1152H	1212D	4708H50	60	290	113037

## SERIE XPE COMPLETE HYDRAULIC SET

XPE



XPE complete hydraulic set.

In addition to the puller described in the table, it includes:.

- 2 pairs of extra extensions.

- 2 joining nuts.

Point protector.



### Bullet points

- Hydraulic system: faster pulling with less effort.
- Versatility: with one set you can have many possibilities of extractions.
- Palletized black metal box.
- Extra large jaws (4hole).

Can be mounted

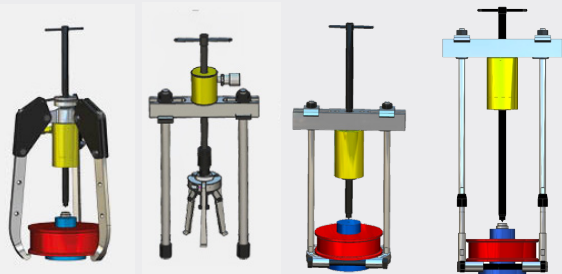

Ref.	Price/€	TON	⚖️	Hydraulic part	Mechanical part
XP-10E	3.707,00	12	58	00910	X0-10E
XP-20E	4.898,00	20	93	00918	X1-18E
XP-30E	7.575,00	30	172	00930	X2-30E
XP-50E	12.990,00	60	337	00952	X3-50E

### Hydraulic part



### Mechanical part



# • HYDRAULIC MASTER SETS •

## SERIE C3008 COMPLETE HYDRAULIC PULLER

C3000



Allow three types of uses:  
 -2/3 oscilating jaws puller.  
 -2 fix jaws pullers.  
 Point extension included.



### Bullet points

- Hydraulic system: faster extraction with less effort.
- Versatile for maintenance operations.

Ref.	Price/€	TON	⚖️	Hydraulic part	Mechanical part	Splitter
C3008	1.942,30	5	29,0	00904	1108HF 1307LTH	1204B
C3009	3.026,30	10	50,0	00909	1120HF 1310LTH	1206B

### Hydraulic part



Cylinder

Hose

Pump

Manometer

### Parte mecánica

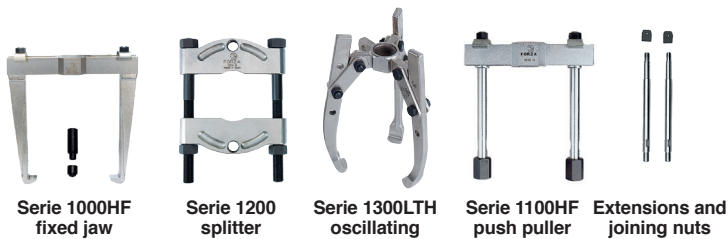

Serie 1000HF  
fixed jaw

Serie 1200  
splitter

Serie 1300LTH  
oscillating

Serie 1100HF  
push puller

Extensions and  
joining nuts

### Can be mounted

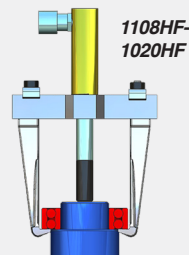

1108HF-  
1020HF

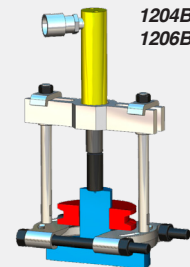

1204B + exten.  
1206B + exten.

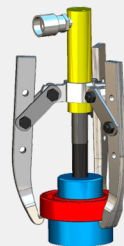

1307LH (2 jaws)  
1307LTH (3 jaws)

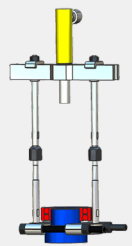

1108FH +  
EXTENSIONS  
+ 1204B



SEE VIDEO



# • BOLTS PULLERS •

## MECHANICAL BOLT PULLER

42050

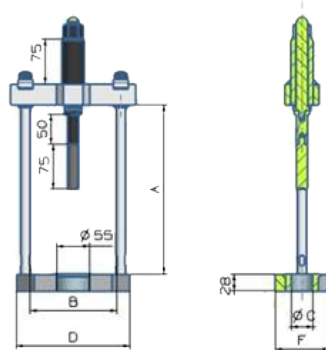

Mechanical compression bolt puller for bolts up to Ø55mm diameter. Includes 4 adapters for different diameters.



### Bullet points

- Mechanical screw spindle allows hammer striking for bolt extraction.
- Allows height extension up to 280mm with extra extensions and coupling nuts.
- Very easy to assemble.

Ref.	Price/€	A (Useful jaw height)	B (Maximum opening)	Ø Bolt	D	F	⚖️
4205	359,00	154	145	25-40	190	90	7.2

## 5 TON HYDRAULIC BOLT PULLER MECHANICAL PART

4205H0



Mechanical part of the compression bolt puller for bolts up to 55mm diameter. Includes 4 adapters for different diameters.



### Bullet points

- Hydraulic system: faster extraction with less effort.
- Allows height extension up to 280mm with extra extensions and coupling nuts.
- Very easy to assemble.

Ref.	Price/€	A (Useful jaw height)	B (Maximum opening)	Ø Bolt	D	F	⚖️
4205H	454,00	280	145	25-40	190	90	7.6

## FORZA 5 TON HYDRAULIC BOLT PULLER COMPLETE

4205HC0

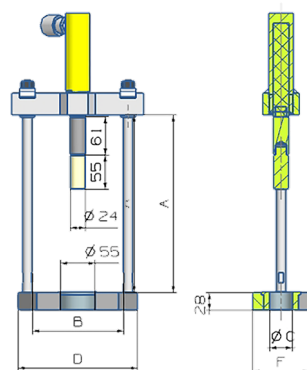

Complete compression bolt puller for bolts up to 55mm diameter. Includes 4 adapters for different diameters.



### Bullet points

- Hydraulic system: faster extraction with less effort.
- Allows height extension up to 280mm with extra extensions and coupling nuts.
- Very easy to assemble.



Ref.	Price/€	Hydraulic part	Mechanical part	⚖️
4205HC	1.654,50	00904	4205H	24

## HYDRAULIC BOLT PULLER

4200H

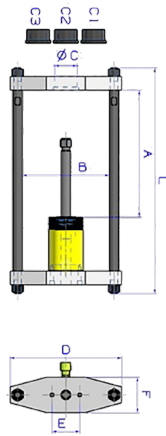

Specially designed to extract large bolts.  
It uses the same hydraulic part as the pullers.  
Available in 30 and 60 tons.



### Bullet points

- Hydraulic system: faster pulling with less effort.
- Includes 3 caps of different sizes.

Ref.	Price/€	A (Useful jaw height)	B (Maximum opening)	ØC	C1 Ø Hole	C2 Ø Hole	C3 Ø Hole	D	E Hole Spacing	F Body Width	L Overall Length	⚖
4230H	1.961,30	420	288	75	60	50	40	370	92	118	750	37
4260H	3.078,60	475	398	95	80	70	60	520	130	175	900	104

## COMPLETE HYDRAULIC BOLT PULLER

4230HC0

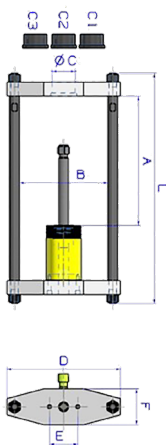

Specially designed to remove large bolts.  
It includes the same hydraulic part as for the others hydraulic  
pullers.  
Available in 30 and 60 tons.



### Bullet points

- Hydraulic system: faster pulling with less effort.

Ref.	Price/€	⚖	Hydraulic part	Mechanical part	Point protector
4230HC	4.282,30	78	00930	4230H	113037
4260HC	7.436,80	165	00952	4260H	113037

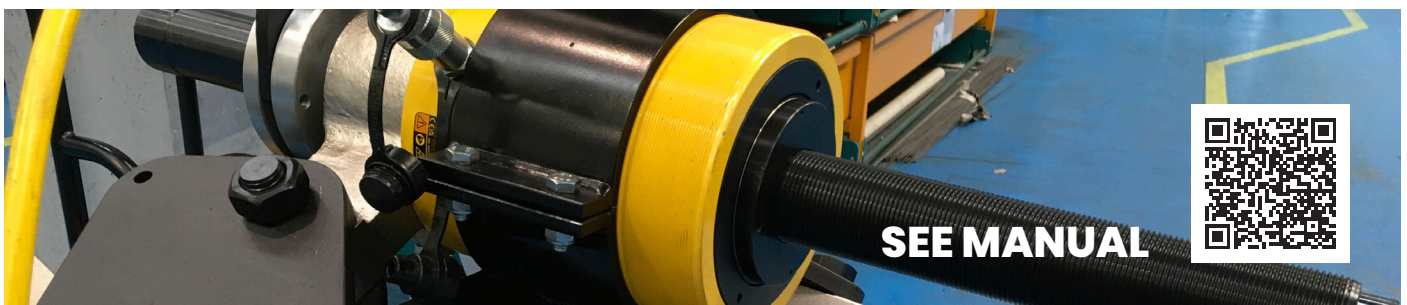

SEE MANUAL



# • BOLTS PULLERS •

## MECHANICAL PART OF 20-TON PULLER FOR BOLTS

P1-180



Puller designed for removing and installing shafts and pins in agricultural and public works machinery up to 830 mm pin length. Extraction is performed by pulling the shaft. Can also be used for shaft installation.



### Bullet points

- Allows extraction of very long shafts or pins.
- Pulling extraction method makes machine width irrelevant.
- Versatility: includes different adapters and allows pulling at different heights.
- Includes shaft protectors for hammering without damaging the shaft.

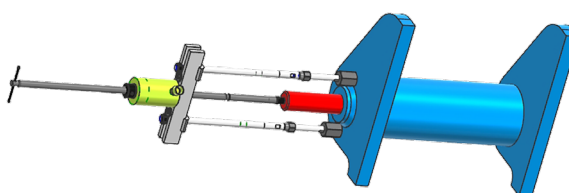

Ref.	Price/€	Maximum opening	Maximum height	Adapters	Protectors	⚖️
P1-18	1.299,00	345mm	828mm	5 adaptadores de M12 a M20	5 protectores de M12 a M20	18.5

## 20-TON HYDRAULIC PULLER FOR BOLTS

P1-18COM0



Ref.	Price/€	TON	⚖️	Hydraulic part	Mechanical part
P1-18COM	3.510,00	20	39	00918	P1-18

# • HYDRAULIC RAM PULLER •

## SERIE 1300CTA SELF CENTERING HYDRAULIC RAM PULLER

1300CTA









Self centering hydraulic ram puller with pump and cilinder integrated.  
Long jaws (3 holes).

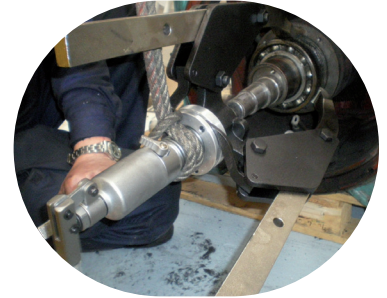

### Bullet points

- Hydraulic system: faster pulling with less effort.
- Hydraulic ram spindle. It does not require a hydraulic pump.
- Self-centering system: automatic centering of the jaws for a better grip.
- The pull out improves thanks to the three jaws.



Ref.	Price/€					Combines	TON		Spare parts	
									Jaw	Hydraulic spindle
1306CTA	878,00	300	310	50	220	2/3 Patas	6	14.2	131005	00806
1306CLTA	892,70	380	360	50	220	2/3 Patas	6	15.1	131006	00806
1306CXTA	983,50	460	410	50	220	2/3 Patas	6	16.3	131016	00806
1308CTA	1.191,50	370	425	70	205		8	21.7	131705	00808
1308CLTA	1.254,00	485	480	70	205		8	23.8	131706	00808
1308CXTA	1.354,10	600	540	70	205		8	27	131716	00808

## SERIE 1300CTH HYDRAULIC RAM PULLER

1300CTH





Hydraulic ram puller with pump and cilinder integrated.  
Long jaws (3 holes).



### Bullet points

- Hydraulic system: faster pulling with less effort.
- Hydraulic ram spindle. It does not require a hydraulic pump.
- The pull out improves thanks to the three jaws.

Ref.	Price/€			TON	Combines		Repuesto	
							Complete jaw	Hydraulic jaw
1306CTH	689,70	300	310	6	2/3 Patas	10.2	131050	00806
1306CLTH	704,40	380	360	6	2/3 Patas	11.2	131060	00806
1306CXTH	795,20	460	410	6	2/3 Patas	13.6	131066	00806
1308CTH	885,10	370	425	8	-	19.5	131750	00808
1308CLTH	975,20	485	480	8	-	21.5	131760	00808
1308CXTH	1.038,80	600	540	8	-	23.5	131766	00808

# • COMPACT SPINDLE PULLER SET •

## HYDRAULIC COMPACT SPINDLE PULLER SET C1004-C1006

C10040



8 tones hydraulic puller set with compact spindle.  
For external and internal use.  
Do not use wrenches or levers to tighten the sub-spindle.  
They are supplied in a cardboard box.



### Bullet points

- Hydraulic system: faster pulling with less effort.
- The force is applied directly to the body.
- Faster assembly.

Ref.	Price/€	Puller	Long puller	Splitter	Push puller	⚖️
C1004	851,40	1010H	1010LH	1204B	1108H	11.3
C1006	1.072,60	1010AH	1010LAH	1206B	1108AH	15

## HYDRAULIC COMPACT SPINDLE PULLER SET C1005-C1012

C10050



8 and 12 Tons hydraulic puller set with compact spindle.  
For external and internal use.  
Do not use wrenches or levers to tighten the sub-spindle.  
They are supplied in a red case.



### Bullet points

- Hydraulic system: faster pulling with less effort.
- The force is applied directly to the body.
- Faster assembly.

Ref.	Price/€	Puller	Long puller	Splitter	Push puller	TON	⚖️
C1005	1.109,00	1308TH	1010LH	1204B	1108H	8	14.5
C1012	1.222,00	1312TH	1012LH	1204B	1108AH	12	15

## HYDRAULIC COMPACT SPINDLE PULLER SET C1015

C1015S



15 Tons hydraulic puller set with compact spindle.  
For external and internal use.  
Do not use wrenches or levers to tighten the sub-spindle.



### Bullet points

- Hydraulic system: faster pulling with less effort.
- The force is applied directly to the body.
- Faster assembly.

Ref.	PVP/€	Puller	Long puller	Splitter	Push puller	TON	⚖️
C1015	1.850,40	1315LTH	1016H	1206B	1116H	15	53,0
C1015L	2.047,90	1315LTH	1016LH	1206B	1116H	15	56,0

# • TROLLEY FOR PULLERS •

## COMPLETE 100 TON PULLER WITH TROLLEY

973000



It consists of the 970100 trolley plus the 3395THA hydraulic puller. Pump for puller ref. 1395THA (09522): two-speed pump. Maximum pressure 700 bar. Pump to raise the cart (09102) : single speed manual pump. Maximum pressure 700 bar. Spindle with manual handwheel to change the angle of the extractor. The puller can be removed from the trolley to use it separately. The puller can be removed from the trolley to use it separately. Equipped with profiles to use load bulls and with slings to load with a crane.

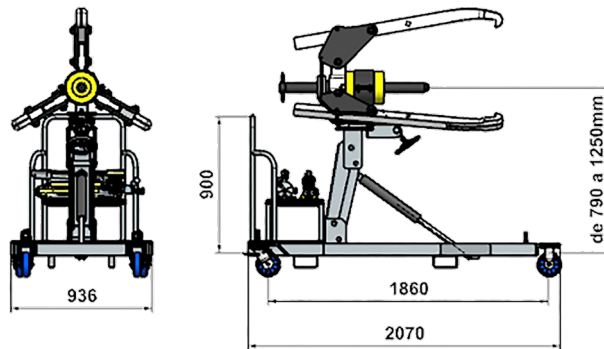

Ref.	Price/€	Carriage length (mm)	Carriage width (mm)	Puller minimum height (mm)	Puller maximum height (mm)	Pump	⚖️	Mechanical part	Complete
973100	25.610,00	2070	936	790	1250	Incluida	590	1395THA	3395THA

## TROLLEY WITH PUSH PULLER AND SPLITTER

970095



Composed of carriage 970100 plus hydraulic bridge and separator. Pump for lifting the carriage (09102): single-speed manual pump. Maximum pressure 700 bar. Spindle with handwheel to change the puller angle. The puller can be removed from the carriage for independent use. Equipped with profiles for forklift handling and lifting eyes for crane loading.

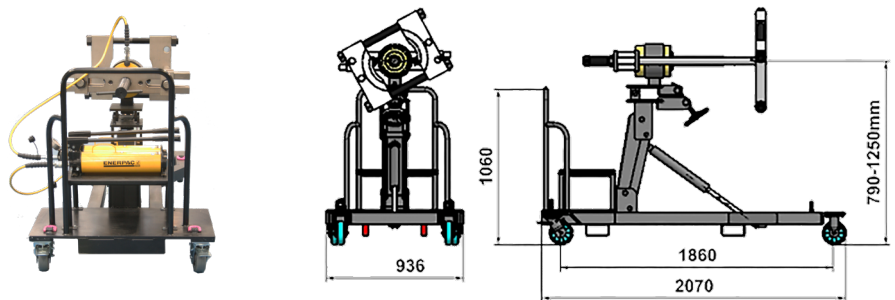

Ref.	Price/€	Carriage length (mm)	Carriage width (mm)	Puller minimum height (mm)	Puller maximum height (mm)	Pump	Cylinder puller 100 Ton	⚖️	Push puller	Splitter	Cylinder
973195	25.850,00	2070	936.	790	1250	Incluida	Incluida	590,0	1195H	1213E	09951



# FORZA®



San Miguel de Acha, 24  
01010 VITORIA · España



Teléfono:  
+34 945 24 97 16



export@forza.es  
www.forza.es